

B

VS 10-75 CG OPTIMA
VS 40-150 CG OPTIMA SUP
VS 40-150 CG OPTIMA SUP-EXH

APPLICATION: AS1-S / AS1-R



common ground terminal GND



common terminal 24VAC

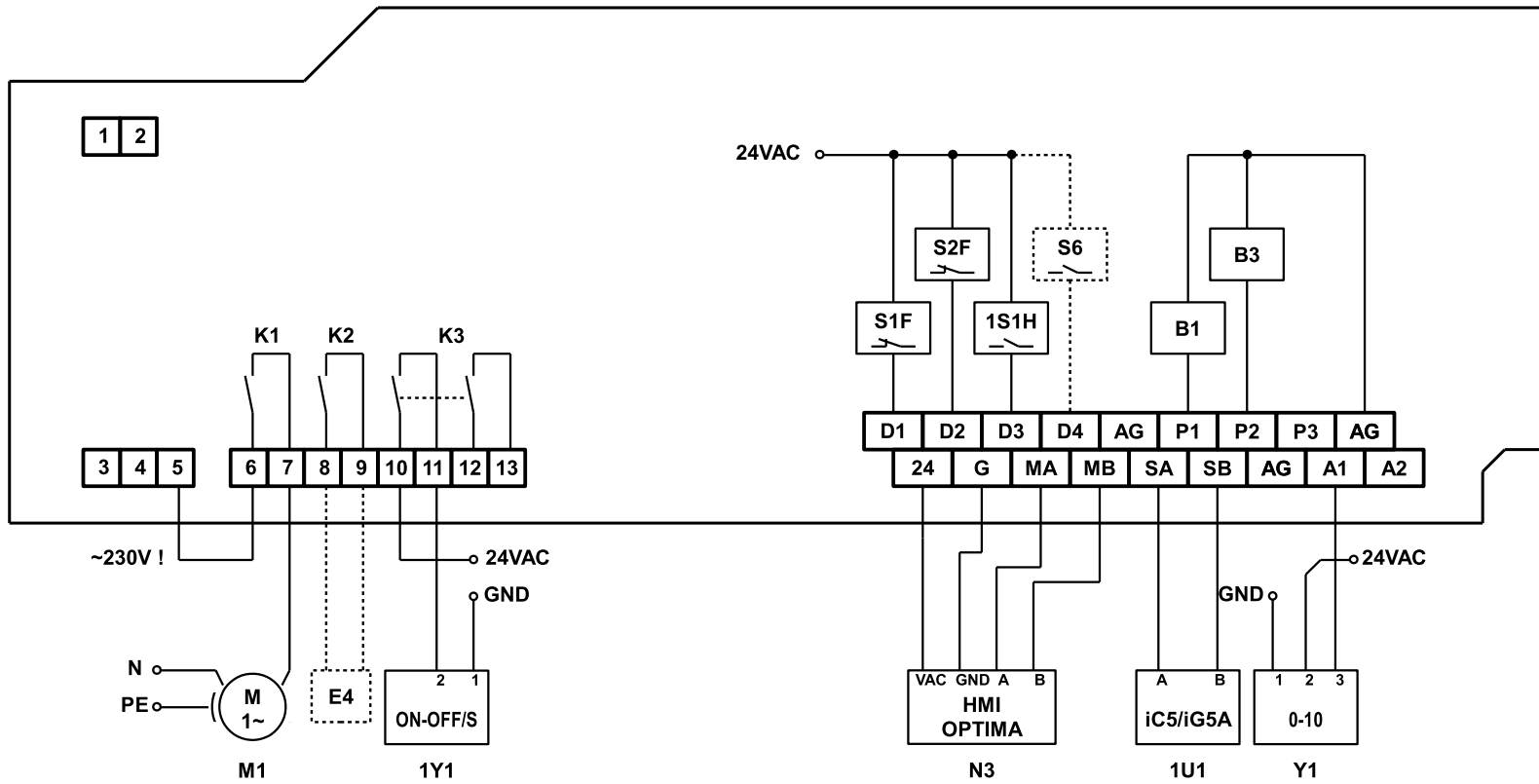

B

VS 10-75 CG OPTIMA
VS 40-150 CG OPTIMA SUP
VS 40-150 CG OPTIMA SUP-EXH

RS485 / Modbus connection details

